

Q: WANT HIGH TECH ?

A: ASK *INAV*

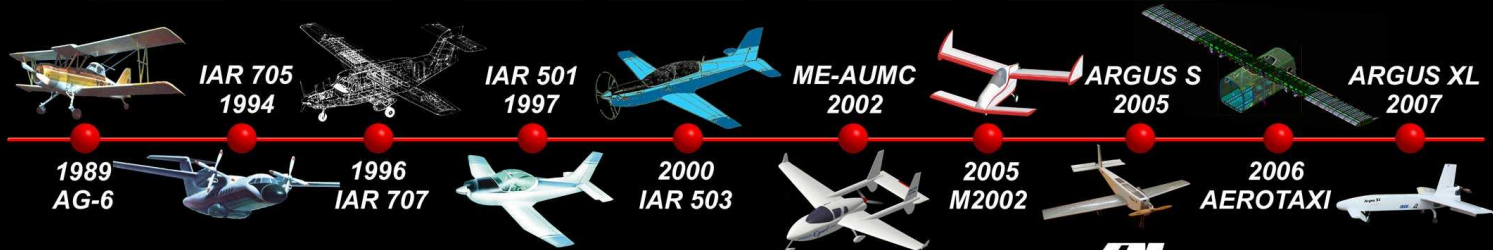

INAV



PRODUCTS AND SERVICES OFFER

Contents:

- I. S.C. INAV S.A. - General presentation
- II. Products and services offer
- III. Contact details

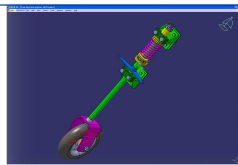

January 2012

I. PRESENTATION OF S.C. INAV S.A.

1. History

We can consider that the history of INAV begins in 1950, together with more entities of the aerospace domain, the foundation of “*Applied Mechanics Institute*” as part of The Romanian Academy. Later, in 1965, the institute separated and became *the Institute for Fluid Mechanics* oriented on aeronautics and space. Starting with 1968 the *Aerospace Research and Development Institute* has been born and later was organized as *Fluid Mechanics and Aerospace Research Institute (IMFCA)*. This institute assumed the primordial role in the Romanian aeronautical and space research.

Ten years later, IMFCA was restructured becoming *The National Institute for Technological and Scientific Research* and in 1985 it will be renamed as the *Institute for Aerospace Scientific Research and Technological Engineering (ICSITAV)*.

In 1990, the entire national aeronautical field was restructured and ICSITAV became *The National Aviation Institute*, at that time the only research entity in aerospace for Romania.

Later, in 1991, the institute was restructured together with all of the aeronautical industry onto research and development entities: ORCAS, IMFZ, STRAERO, **INAV**, ELAROM, SIMULTEC and CPCA.

2. Mission

S.C. INAV S.A. is a research and development institute in the field of natural science and engineering. Our main line of research is airplanes construction with capabilities in structures calculus and design, aerodynamics, flight mechanics, stability, equipments, design of onboard and land systems and subsystems and fundamental aerospace research.

In present we are working on various airplanes projects from the smallest UAV's to passengers aircrafts in our own conception or on various partnerships. We are seeking to raise our scientific and technical level for achieving the integration in the European research system for participating in large-scale projects.

INAV is applying the results of aeronautical research projects in various fields like: green and unconventional energy sources, space research, **special materials, security and aerial surveillance**, environment and environment protection.

3. Values

PROFESIONALISM – management of human and material resources, continuous personal training, attracting experts from various fields outside the aeronautical system.

CAPABILITIES – developing and implementing capabilities using our resources regarding industry needs.

FELXIBILITY – simple structure, fast adaptability to allow fast expansion but also fast drawback

COOPERATION – accessing a value circle that will allow us to securely reach our goals.

EFICIENCY – reaching our goals optimising resources and cutting losses

CREATIVITY - developing concepts, principles and ideas at the profound and abstract level for research and implementing them in practical applications.

4. Goals

- Trust of partners and customers

Beliefs that supports the goal:

- The trust of our partners and customers in us is the dependable of our continuous success
- To gain our partners and customers trust is essential to listen truly to their needs and give them solutions that will be found in their success
- Our competitive pricing of property, quality and ingenuity as our way of doing business are the main fidelity reasons of our partners and customers

- Development

Our company see the changes on the market as opportunities of development, using our profit and abilities to develop innovative products, services and solutions for rapid customer satisfaction.

Beliefs that supports the goal:

- The development assumes calculated risks based on economical analysis of current situation over the industrial environment and further more developing and implementing changes that will lead to success.
- The diversity of our research projects gives us the ability to adapt the economical cycles in our advantage.

- Visibility

Support ideas of the goal:

- Expanding our company trough continuous development of important products, services and solutions for the markets that we are acting now and expanding to new ones.
- To be a medium level on a market does not suffice we are struggling to win.
- We have to be the first or on the second position in the fields that we have chosen.

II. PRODUCTS AND SERVICES OFFER

Our services in the field of research and engineering are based on the following activity fields:

1. Aerospace and naval research & design services for military and civilian applications
 2. Research and design services for mechanical engineering
 3. UAV systems development
 4. Wind turbines development
 5. Providing and implementation of communication systems
 6. Consultancy and partnerships for research grants both national and European funding
 7. Services for civil aircraft evaluation and civil aircraft parts evaluation
 8. Standards elaborations
 9. Office spaces for rent
1. **Aerospace and naval research & design services for military and civilian applications** are part of the main domain of INAV S.A. We are expanding further the main activities regarding these services:
- a. Conceptual and detailed design of aircraft projects according to actual standards.
 - b. Conceptual and detailed design of aeronautical structures.
 - c. Aero dynamical calculus and simulations
 - d. Stress calculus and simulation
 - e. Research studies and design of airport infrastructure.
 - f. Research and design of special military equipments including ammunition
 - g. Tooling for aircraft skins manufacturing
 - h. Underwater autonomous vehicles
- a. INAV can coordinate and manage aircraft development programs in own design and conception with various specialized partners both from Romania and the EU.
 - b. Conceptual and detailed design of aircraft structures, onboard systems and simulations regarding aircraft internal space, gravimetric and cinematic utilizing **CATIA V5** (leading industry software solution of Dassault Systemes).
 - c. Aerodynamics calculus and simulations are done by utilizing our own software packages and utilities modelled and shaped for every specific need.
 - d. Stress related simulations are done using our own software packages and utilities modelled and shaped for every specific need.
 - e. Airport design projects including ground systems and equipments and specific problems consulting.
 - f. INAV is developing in own conception and design projects for upgrading and modernization of military aircrafts. The projects are aimed to replace the actual equipment and systems with high quality systems for control, communications and of course aircraft structures modifications. INAV has designed and prototype testing of military aircraft ammunition. INAV is manufacturing life saving equipments with civil and military applications. This category includes:
 - lifeboat for the IAR-99 airplane

- lifeboat for various helicopters
 - life jacket
 - Tents and tents-hospitals for civil response teams.
- g.** The commercial links with Romanian airplane factories lead to the development of a very complex tooling for parts control and parts cutting & drilling. The complexity consists in precision, number of component parts and big physical dimensions.
- h.** INAV developed two underwater autonomous vehicles (unmanned submarines) for private companies, both of them using composite materials and metallic structure. The first one has 800 kg displacement and the second one has 5.2 tons displacement. The missions accomplished are related to port surveillance and in-land waters surveillance.

Experience – is revealed from various projects that we concluded along our history:

- military aircrafts – we have participated in the IAR-93 and IAR-99 programs
- civil aircrafts
 - MEAUMC “Egret” –4 places ultra light aircraft from composite materials
 - M2002 – single seated ultra light aircraft for hobby use
 - AG-6 – agricultural plane
 - IAR 501 – two seated acrobatic plane
 - IAR 503 – turbo propeller advanced training acrobatic plane
 - IAR 705 – aircraft for passengers or cargo
 - IAR 707 – 13 seats single engine aircrafts
- aviation bombs, ammunition and underwater systems
 - anti-runway free fall bomb with optimised profile
 - non-lethal grenades launcher for anti terrorism actions
 - sequential detonator for non-lethal grenades
 - mini sub for underwater surveillance in harbours areas
 - tooling for Boeing 737 and Skylander passenger airplanes

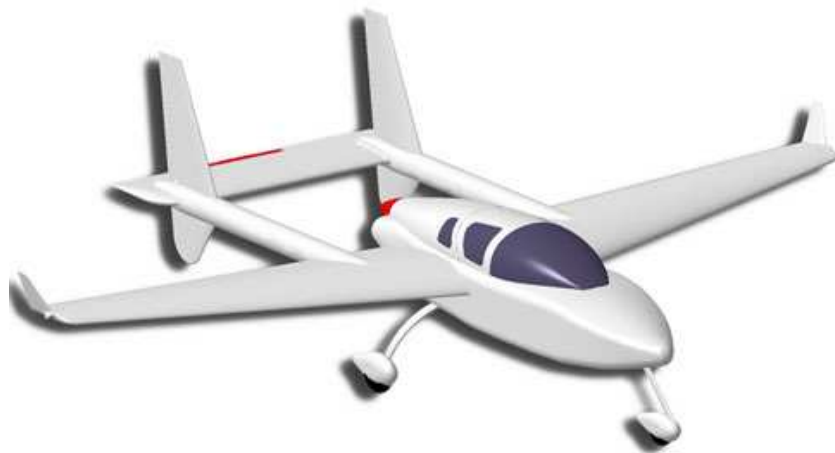

ME-AUMC - Egret

3D model
(CATIA V5 screenshot)



M2002

**INVENTIKA Exhibition
2006**



AG-6

Bacau Airport

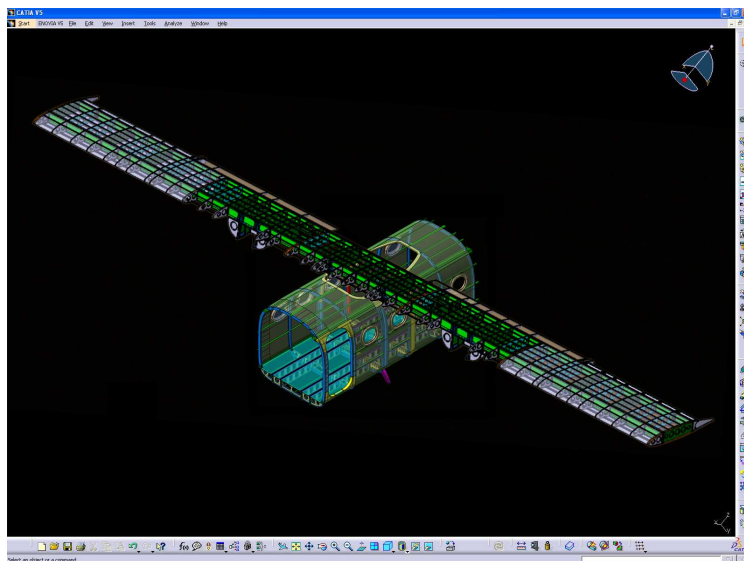

AEROTAXI

**Designing process
(CATIA V5 screenshot)**



BAP-100

**Anti-runway bomb
(BSDA Exhibition 2007)**



Lifeboat

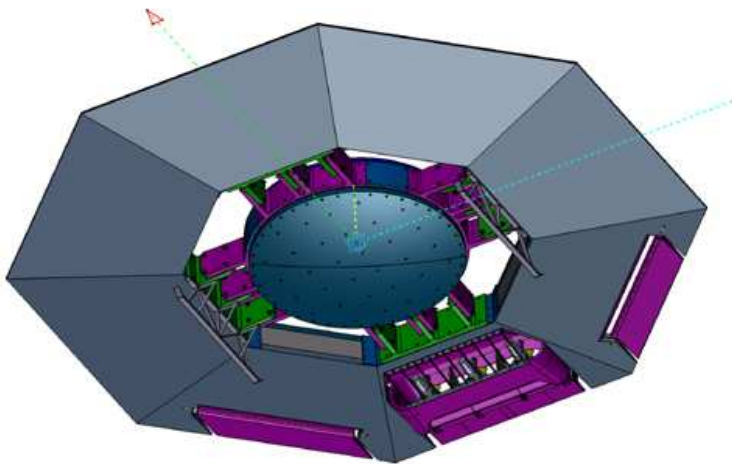

**ROV - Unmanned
submarine**

**Designing process
(CATIA V5 screenshot)**

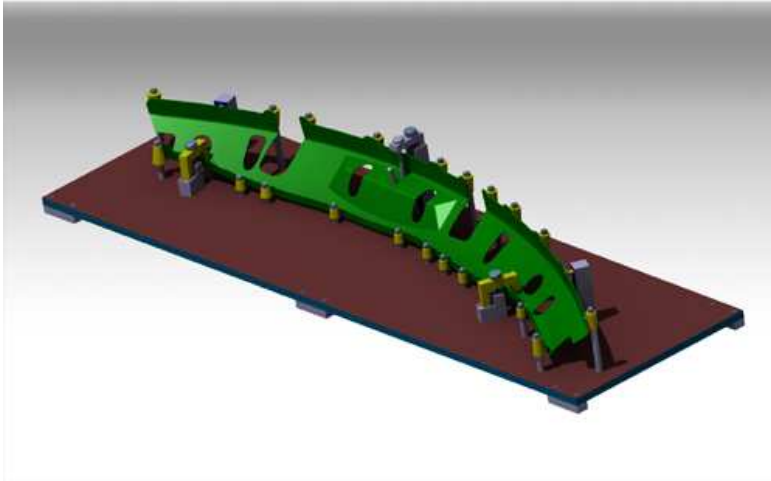

Control tooling

Designing process
(CATIA V5 screenshot)

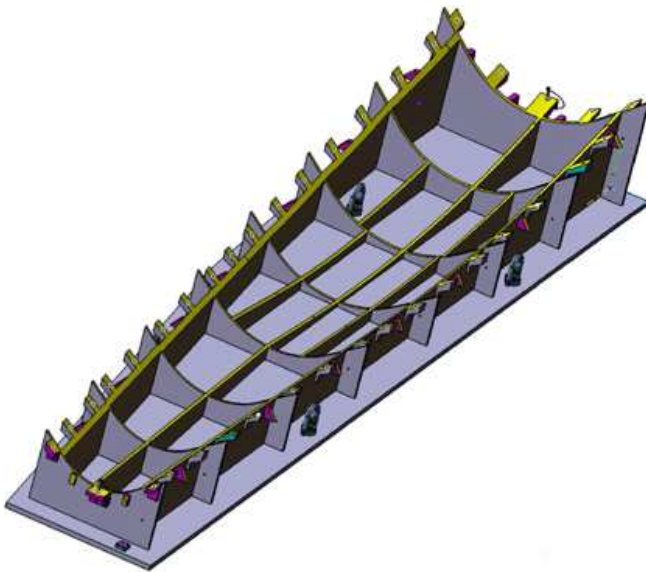

Cutting&Drilling tool

Designing process
(CATIA V5 screenshot)

2. Research and design services for mechanical engineering plays an important part in our activity. Our engineering services have been used by various clients from Romania and abroad.

The design is made using **CATIA V5** (Dassault Systemes software solution) the projects having the support, if needed or requested, of the stress department. The projects have a large complexity and require high project management abilities:

Experience – from own conception projects:

- press for mounting and dismounting train wheels shaft bearings
- high capacity seawater pumps (abroad clients)
- bulkhead for Isalnita water dam
- installation for gallery cementing at Rastolnita hydroelectric power station
- hovercraft installation for water gallery inspection at Vidra lake
- road lighting sources for Contactoare Buzau



**Press for
mounting/dismounting
train bearings**

(In function at client site)



**CARINA - Ohmmeter for
train coupled axle
electric resistance
measurement**

(In function at client site)

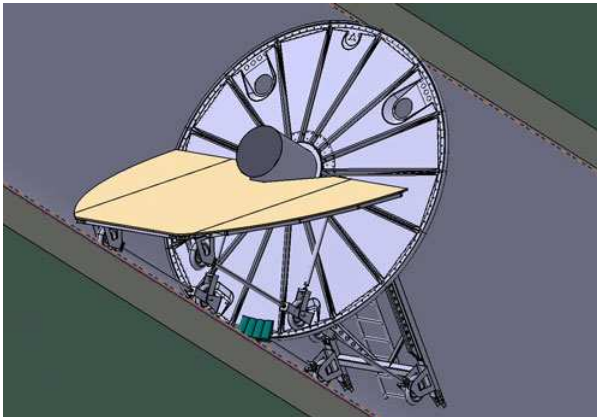

Hovercraft installation

**3D model
(CATIA V5 screenshot)**

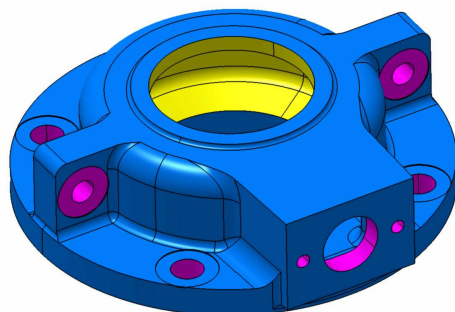

**Part of high capacity
seawater pump**

**3D model
(CATIA V5 screenshot)**

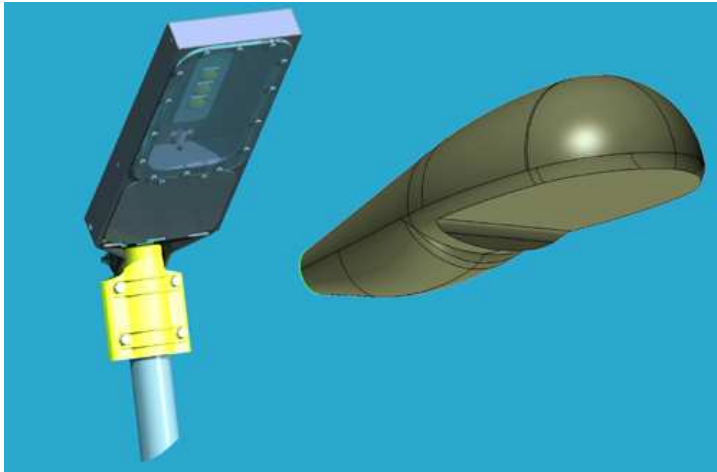

Road lighting source

**Designing process
(CATIA V5 screenshot)**

3. UAV systems development – this is one of our main developing directions under continuous growth.

The development activities of these systems is starting from clients requests but on demand INAV can offer consultancy regarding the generation of *operations concepts* for these systems:

The development capacities of INAV team are:

- conceptual design and detailed design of vector (UAV type aircraft)
- manufacturing of composite materials UAV structures at 5m long and 150 kg maximum take-off weight.
- Onboard equipments integration: communication equipments (telemetry and video), navigation systems, propulsion systems, emergency recovery systems etc.
- Ground station equipment integration for power, guidance, telemetry and video data link.

Experience – in this field we have 4 UAV systems developed under INAV management in various research consortiums. The funding for this systems where obtained by winning research competitions.

Our UAV portfolio:

- **ARGUS S** – small UAV system for aerial surveillance;
- **ARGUS XS** - small UAV system form missions regarding forest surveillance
- **ARGUS XL** - medium size UAV for tactical missions of surveillance and reconnaissance
- **LOCATS** - LOw Cost Aerial Target System



ARGUS XL - UAV SYSTEM

Taxi tests



ARGUS XL - UAV SYSTEM

Take off



ARGUS XS - UAV SYSTEM

Flight tests



ARGUS XS - UAV SYSTEM

Dusk landing
(flight tests)



ARGUS XS - UAV SYSTEM

Video capture from
onboard camera
(real time transmission)

4. Wind turbines development is a new direction in business development. In this light, INAV institute is involved in designing wind turbines with nominal power between 5 and 20 kW.

The usage of specific design standards, the aerodynamic and stress calculus and simulations together with the 3D assisted design place the wind turbines in the sphere of the high performances products.

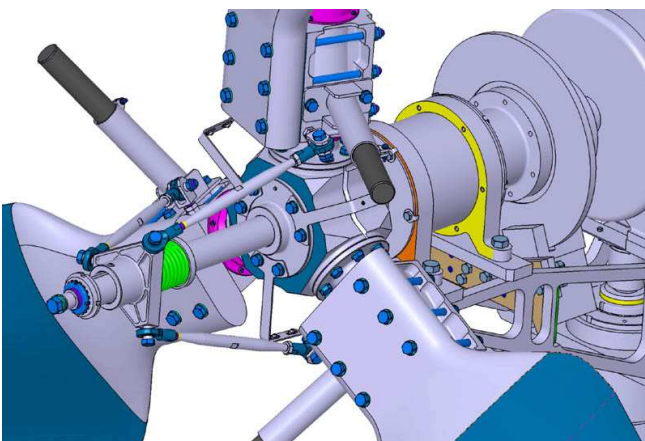

CE5 Wind Turbine

(3D view of the rotor)

5. Providing and implementation of communication systems.

INAV institute is partner of **ITALIANA PONTI RADIO** regarding development and implementation of long-range communication systems. The products and systems are for military and civilian use.

INAV S.A. has the possibility to **provide personalized and unique communication solutions** for long-range communication according to every client requirements.

Our portfolio of long-range communication solutions for civil and military applications is composed of products based on **COFDM** technology:

- equipments for onboard and ground stations for aerial surveillance systems (telemetry and video);
- communication equipments for mobile and stationary ground stations;
- sniper synchronization systems;
- radio jamming systems;

The civilian portfolio is composed mainly from television and radio equipments based on COFDM technology for both analog and digital transmissions.



COFDM Ground station receiver



Auto tracking antenna

6. Consultancy and partnerships for research grand both national and European funding

INAV S.A. can be a consultant for participating at research competition from Romania or EU. Our experience allows us to participate in national or European research consortiums as partner or coordinator.

INAV S.A. is listed in **“Registrul potentialilor contractori”** (THE REGISTRY OF POTENTIAL PARTNERS) = as a private research and development company.

Experience – is based on the large number of national funding research projects that we won over the years and of course the number of partnerships for European programs.

7. Services for civil aircraft evaluation and civil aircraft parts evaluation

Our evaluation services are based on synchronizing procedures with the actual legislation made by specialized personnel.

The main client of these services is TAROM (air Transport Company) that made evaluations for BAC 1-11, Boeing 707, Antonov AN-24V and Airbus A310-325 aircrafts and various equipments and systems.

8. Standards elaborations

INAV has the presidency of three technical standards committees, (CT72, CT296, and CT303) which are part of ASRO – Romania Standards Association, for developing national standards regarding the aeronautical field.

Our standards services are focused on:

- National standard synchronization with the EU standards
- New standards proposal in breach market domains
- Evaluation and support regarding aeronautical standards

9. Office spaces for rent

INAV offer for office space rental comprise 880 sqm. with the following facilities:

- access control
- fire fighting systems
- data/voice network
- internet access

III. CONTACT



S.C. INAV S.A.

Virgiliu BANCILA – General Manager
Camelia ULEA – Commercial Manager

Office address:

44A Ficusului Blvd. 013975 Bucharest, ROMANIA

TEL/FAX: +40 21 232 37 24
+40 21 232 76 67
+40 21 232 68 87

E-mail: inav@inav.ro

Web: www.inav.ro